

3655-02/03 Sleeve Dial Pulse Originating (SDPO) Installation Guide

CONTENTS	PAGE
Part 1. GENERAL	1
Part 2. INSPECTION	1
Part 3. INSTALLER CONNECTIONS	2
Part 4. OPTIONS INFORMATION	2
Part 5. ALIGNMENT	2
Part 6. MOUNTING	2
Part 7. TECHNICAL ASSISTANCE	6

1. GENERAL

1.1 Document Purpose

This document provides installation instructions for the Charles Industries 3655-02/03 SDPO Channel Units.

1.2 Document Status

This document is reprinted to include a general editorial update

1.3 Equipment Function

The Charles 3655-02/03 SDPO Channel Units are used in the Charles 360 D4 Digital Carrier Terminal. The functional differences between 3655-02/03 SDPO channel units are listed below. Also refer to the Figure 1 Block Diagram. For detailed information on the 3655-02/03 SDPO channel units, see Section 365-501-206.

Model #	Description
3655-02	2-wire dial-pulse-originating trunk interface with sleeve, helping sleeve, and all-trunks-busy leads.
3655-03	2-wire dial-pulse-originating trunk interface with sleeve, helping sleeve, and all-trunks-busy, and peg count leads.

2. INSPECTION

2.1 Inspect for Damages

Inspect the equipment thoroughly upon delivery. If the equipment has been damaged in transit, immediately report the extent of damage to the transportation company.

2.2 Equipment Identification

Charles Industries' equipment is identified by a model and issue number imprinted on the front panel or located elsewhere on the equipment. Each time a major engineering design change is made on the equipment, the issue number is advanced by 1 and imprinted on subsequent units manufactured. Therefore, be sure to include both the model number and its issue number when making inquiries about the equipment.

2.3 Static Concerns

Each unit is shipped in static-protective packaging to prevent electrostatic charges from damaging static-sensitive devices. Use approved static-preventive measures, such as static-conductive wrist straps and a static-dissipative mat, when handling units outside of their protective packaging. A unit intended for future use should be tested as soon as possible and returned to its original protective packaging for storage.



STATIC-SENSITIVE



This equipment contains static-sensitive electronic devices. To prevent electrostatic charges from damaging static-sensitive units:

- **Use approved static preventive measures (such as a static-conductive wrist strap and a static-dissipative mat) at all times whenever touching units outside of their original, shipped static-protective packaging.**
- **Do not ship or store units near strong electrostatic, electromagnetic, or magnetic fields.**
- **Use static-protective packaging for shipping or storage.**

3. INSTALLER CONNECTIONS

Installer connections are made to the channel unit via connectorized cable connectors that are part of the channel bank assembly. Refer to the appropriate channel bank installer documentation for pin assignments.

4. OPTIONS INFORMATION

The 3655-002/03 channel units are equipped with DIP switches that are used to condition the module for proper application and operation. Refer to Figure 2 and Table 2 for the option locations and option conditioning requirements.

5. ALIGNMENT

The XMT ATTN switch S1 is a prescription control that provides attenuation from 0 to 4.5dB in increments of 0.1dB to accommodate an input TLP range from –4.5 to 0dB. To adjust the transmit path to the proper operation level, the difference between –4.5 and the transmit TLP at T&R must be obtained.

$$[\text{XMT ATTN} = \text{TLP} - (-4.5)]$$

For an input TLP of –2.0dBm, the XMT ATTN = (–2.0) – (–4.5) = 2.5dB. Set the sum of the switches on S1 to 2.5.

The RCV ATTN switch S2 is a prescription control that provides attenuation from 0 to 8.5dB in increments of 0.1dB to accommodate an output TLP range from –7.0 to +1.5dB. To adjust the receive path to the proper operation level, the difference between +1.5 and the receive TLP at T&R must be obtained.

$$[\text{RCV ATTN} = (+1.5) - \text{TLP}]$$

For an output TLP of –6.0dBm, the RCV ATTN = (+1.5) – (–6.0) = 7.5dB. Set the sum of the switches on S2 to 7.5.

6. MOUNTING

The 3655-02/03 mounts in one channel unit slot of a 360/363 D4 Terminal. The 3655-02/03 is equipped with an insert/eject lever in the form of a hinged front panel. The insert/eject lever ensures positive connection of a channel unit's card-edge connector to the backplane connector when the unit is installed and also provides easy removal of the unit.

Align the channel unit with the appropriate card guide slot of the terminal. Slide the channel unit into the slot with the front panel in a horizontal (up) position. When the top portion of the hinged front panel is under the front lip of the terminal, push down on the front panel until it is in the vertical (down) position and apply light pressure until the channel unit snaps into place.

CAUTION

Installation and removal of modules should be done with care. Do not force a module into place. If excessive resistance is encountered while installing a module, remove the module and check the card guides and connector to verify proper alignment and the absence of foreign material.

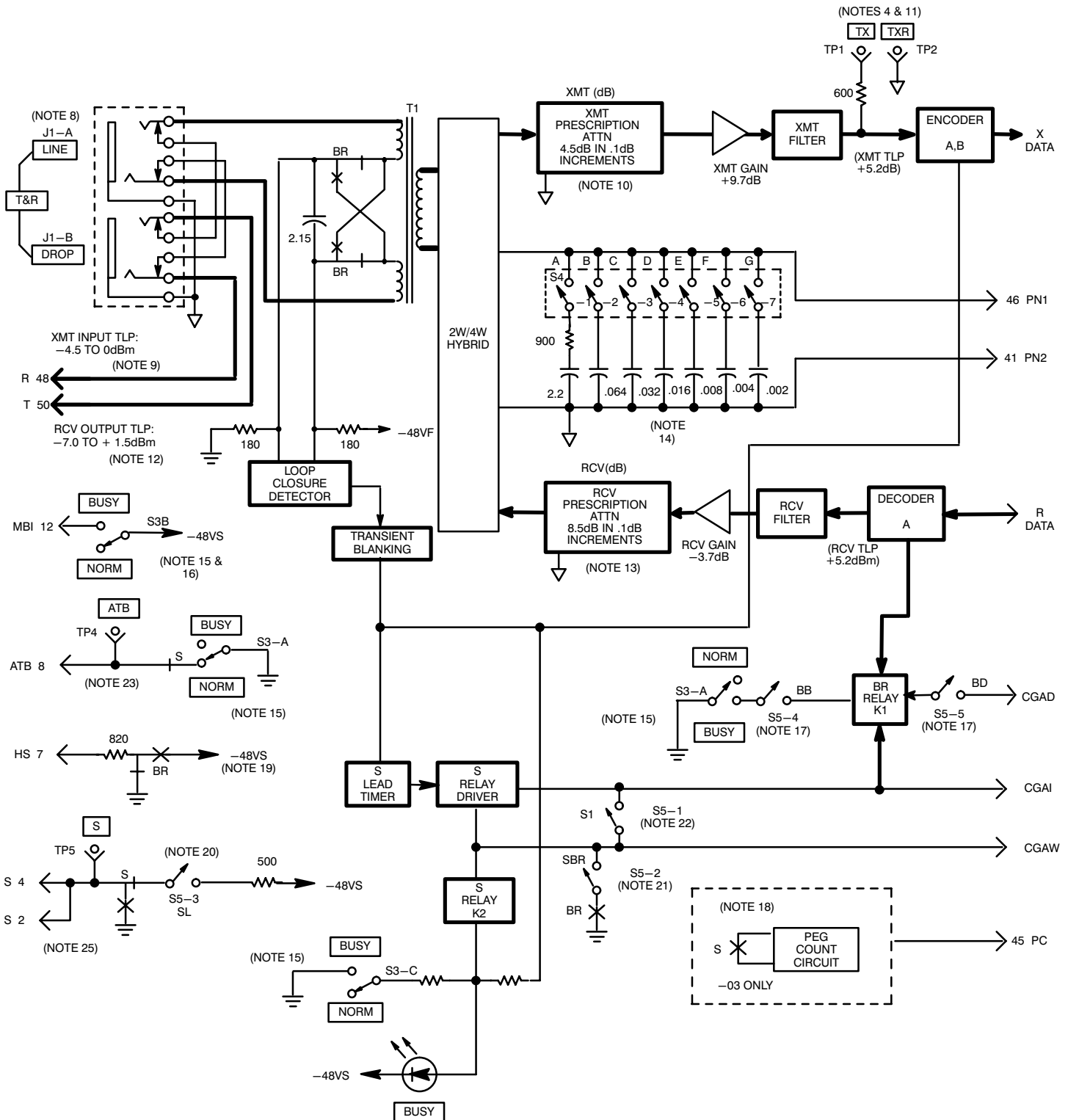
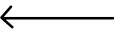

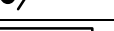
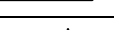
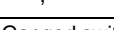

Figure 1. 3655-02/03 SDPO Channel Unit (Issue 6) Block Diagram

Table 1. Notes for Figure 1

#	Note	#	Note	
1.	 PC board connector pin	15.	Busy switch: Switch handle down is normal (NORM) position. Switch handle up is busy (BUSY) position. Busy switch performs the following functions: A. Turns on busy lamp on front edge of units. B. Provides a manual busy indication to the alarm and logic units. C. Provides battery reversal (optional). D. Grounds "S" lead. E. Opens "ATB" lead.	
2.	 Primary transmission path			
3.	 Signal flow direction			
4.	 PC mount test point			
5.	 Front panel marking			
6.	 N.O., N.C. relay contact.			
7.	Ganged switches are indicated by dashed connection line or alphabetically suffixed reference designations; numerical suffix denotes discrete switch within a package.			
8.	PC mount test jacks:		16.	When the channel unit is removed from designated plug-in slot, busy condition (Off Hook) is transmitted to the remote end channel bank.
	Marking	Function		
	T&R Line (J1–A)	Access towards channel unit.	17.	For battery reversal 2.5 seconds after CGA, set switch S5-5 ON. For battery reversal when busy switch in busy position, set switch S5-4 ON.
	T&R Drop (J1–B)	Access towards office equipment.		
	S	Sleeve lead monitor		
ATB	ATB lead monitor	18.	Peg Count Circuit (3655–03 Only): Upon changing from an off-hook to an on-hook condition, PC lead is grounded for 100 to 150 ms.	
9.	The XMT INPUT range at T&R: –4.5dBm to 0dBm. The unit is factory adjusted for –4.5dBm input. The XMT ATTENUATION is set to 0dB.		19.	The "HS" lead is at resistance ground during normal battery and at resistance battery during reverse battery.
10.	The XMT PRESCRIPTION circuit provides 4.5dB attenuation in 0.1dB steps to compensate for office wiring loss and input level variations. Refer to the following table for details.			
	Input (dBm)	0 –2 –4.5		
	XMT ATT (dB)	4.5 2.5 0	20.	"S" lead conditioning: In the idle state, switch S5-3 ON provides resistance battery while S5-3 OFF provides open. In the busy state, "S" lead is always grounded.
11.	The level at the transmit test point, TX & TXR, measured with a bridged meter should be +5.2dBm at 1kHz.		21.	Switch S5-2 ON enables "S" lead to be grounded upon battery reversal.
12.	The RCV output range at T&R: –7dBm to +1.5dBm. The unit is factory adjusted for +1.5dBm output. The RCV attenuation is set to 0dB.			
13.	The RCV prescription circuit provides 8.5dB attenuation in 0.1dB steps to compensate for office wiring loss and output level variations. Refer to the following table for details:			
	Output (dBm)	+1.5 0 –3 –7	23.	The "ATB" lead is grounded in the idle state and open in the busy state. It is also open when the busy switch is in the busy position.
	RCV ATT (dB)	0 1.5 4.5 8.5		
14.	Switch S4-1 through S4-7 (A through G) provides compromise network and build-out capacitance (BOC) for hybrid balance. Open S4-1 (A) when external PBN is used. S4-2 through S4-7 (B through G) provides a total of 0.13uF BOC in 0.002uF steps. The total BOC is set equal to cable capacitance at T&R.		24.	When the unit is removed from its mounting slot, the sleeve lead (pins 2, 4) is grounded through a shorting contact in the backplane connector.

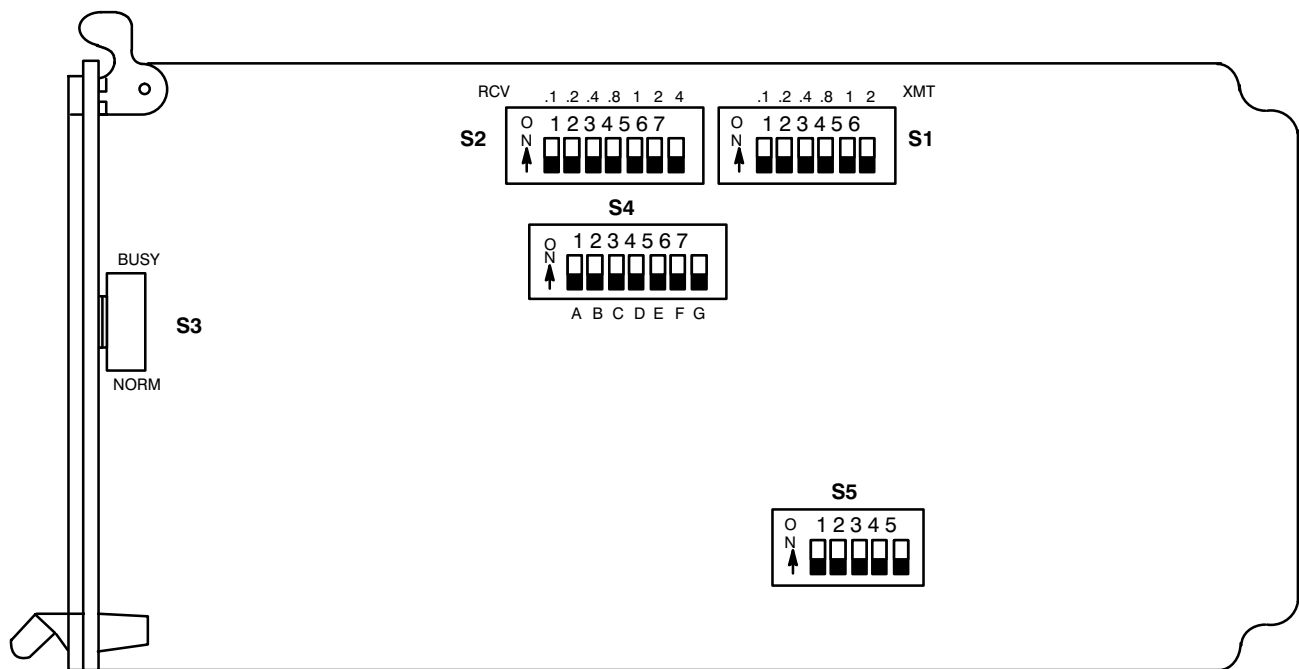

Figure 2. Option Locations

Table 2. Option Summary

Option	Position	Function
S1	See Alignment	Six sections (0.1, 0.2, 0.4, 0.8, 1, 2,) total 4.5dB of XMT ATTN when all are ON.
S2	See Alignment	Seven sections (0.1, 0.2, 0.4, 0.8, 1, 2, 4) total 8.5dB of RCV ATTN when all are ON.
S3	NORM	For normal operation of channel unit.
	BUSY	For testing of channel unit.
S4-1	ON	To select a compromise net resistance of 900 ohms +2.2 μ F.
	OFF	If an external PBN is used.
S4-2 re-thru S4-7	ON/OFF as re- quired	Provides up to 0.126 μ F additional capacitance for balancing of cable capacitance. Place in ON position to add S4-B 0.064; S4-C 0.032; S4-D 0.016; S4-E 0.008; S4-F 0.004; S4-G 0.002 μ F.
S5-1	ON	For S-lead busy immediately upon entering a CGA condition.
	OFF	For S-lead busy upon CGA, with a 70-millisecond wink-off following in 2.5 seconds.
S5-2	ON	For S-lead busy during answer supervision
	OFF	To disable this feature.
S5-3	OFF	For an open S-lead idle state.
	ON	For a -48V (nominal) S-lead idle state.
S5-4	ON	For battery reversal when the NORM/BUSY switch is in BUSY.
	OFF	To disable this feature.
S5-5	ON	For battery reversal at 2.5 seconds following carrier failure.
	OFF	To disable this feature.

7. TECHNICAL ASSISTANCE

If technical assistance is required, contact Charles Industries' Technical Services Center at:

847–806–8500

847–806–8556 (FAX)

800–607–8500

techserv@charlesindustries.com (e-mail)

